

GES is pleased to have been selected the official service contractor by the Show Organizer to design and produce your show. Our goal is to ensure your show participation is a success.

GES is involved in many areas relative to the show and if at any time during the planning process you are unsure where to turn, just ask us, we are at your service.

Please ensure that you review this section carefully as it contains information, **DISCOUNT PRICES** and order forms for each of the many services being provided by **GES**.

For your convenience, we will be offering the following services:

- ✓ **Online Ordering**
- ✓ **Furnishings**
- ✓ **Carpet & Underpadding**
- ✓ **GEM Exhibits & Accessories**
- ✓ **Signs & Graphics**
- ✓ **Installation & Dismantling Labour**
- ✓ **In-Booth Forklift**

To take advantage of our **DISCOUNT PRICING**, all order forms and full payment must be received on or before the Discount Date of December 28 as indicated on each form. **GES** accepts Visa, Mastercard, American Express, Cheques and Cash as methods of payment for our services. All exhibitors are responsible for payment of G.S.T. when exhibiting in Alberta.

If you need assistance or additional information, please contact our **Exhibitor Services Department at (403) 243-2212.**



Accelerate your experience with Expresso exhibit planning, ordering and management.

Exhibitors can order everything they need for their tradeshow exhibit through Expresso, our simple to navigate, picture-driven system that satisfies your need for speed. With just a few clicks exhibitors can order GES products and services including:

- Booth furniture.
- Carpet and flooring.
- Material handling.
- Booth labour.
- And much more.



Expresso is more than just an online exhibitor manual. Exhibitors can:

- Order exhibit products and services.
- Print shipping labels.
- View important show and event information.
- Download the show schedule into Outlook or iCalendar.
- View account order status and history.

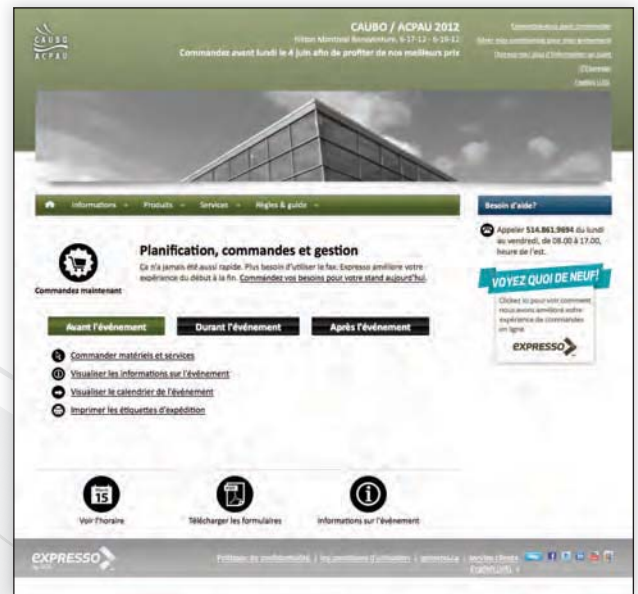

Experience a difference with Expresso.

- Each show has their own custom website.
- Runs on all browsers for PCs, Macs and tablets.
- Everything in one place; all organizer and show information, ordering and even third party forms.
- Keeps you on-time and on-budget.



#25, 5805 - 76 Ave. SE Calgary, Alberta, T2C 5L8 Tel: (403) 243-2212 Fax: (403) 243-3868 Toll Free 1-800-636-8235 www.gesexpo.ca

SHOW: Calgary Renovation Show 2017

EXHIBITOR INFORMATION

BOOTH #: _____

COMPANY _____

STREET _____

CITY _____ PROV/STATE _____ CODE _____

E-MAIL _____

PHONE _____ FAX _____

CONTACT NAME _____

IMPORTANT - READ CAREFULLY

Please fill out The Credit Card Authorization below if:

- You or your company are forwarding payment to GES in the form of a cheque.
- There is any possibility you or your representative will be ordering any service on-site.
- You are ordering Material Handling, Installation and Dismantle Labour or In-Booth Forklift Services.

PLEASE COMPLETE THE FOLLOWING

MASTERCARD
 VISA
 AMERICAN EXPRESS
 EXPIRY DATE:

CORPORATE
 PERSONAL

CARD #

CARDHOLDER'S NAME (PRINT): _____

CARDHOLDER'S SIGNATURE: _____

Cardholder's Billing Address: _____

City: _____ Prov/State: _____ Code/Zip: _____

Tel: _____ Fax: _____

This authorization allows GES to charge any fees outstanding after show closing to this credit card (including funds owed due to a cheque returned NSF)

CHEQUES WILL NOT BE ACCEPTED WITHOUT THIS CREDIT CARD AUTHORIZATION

IF THIS AUTHORIZATION IS NOT COMPLETED, ALL ON-SITE ORDERS ARE EXPECTED TO BE PAID IN FULL BEFORE DELIVERY

TO: **GES**
FAX: **(403) 243-3868**
DATE: _____
FROM: _____
SHOW NAME: **Calgary Renovation Show 2017**
COMPANY: _____
BOOTH #: _____

✓ To help us ensure we have received your entire order, please check off those forms you are sending us:

- Third Party Billing
- Credit Card Authorization
- Furnishings
- Carpet & Underpadding
- Exhibit Accessories
- Signs
- Plants
- Installation & Dismantle Labour Services
- Material Handling
- GES Logistics / Shipping

Please call to confirm receipt of your order.

***To receive Discount Pricing send your order in
by the Discount Price Deadline Date - December 28, 2016***

Thank you from GES



#25, 5805 - 76 Ave. SE Calgary, Alberta, T2C 5L8 Tel: (403) 243-2212 Fax: (403) 243-3868 Toll Free 1-800-636-8235 www.gesexpo.ca

SHOW: **Calgary Renovation Show 2017**

EXHIBITOR INFORMATION

BOOTH #: _____

COMPANY _____

STREET _____

CITY _____ PROV/STATE _____ CODE _____

E-MAIL _____

PHONE _____ FAX _____

CONTACT NAME _____

You may arrange for an exhibit house or other agent to handle your display & be charged for services. GES will agree to this arrangement if the exhibit house or agent makes satisfactory payment arrangements with us. Both firms must complete this form and return to GES by the Advanced Price Deadline Date. It is understood and agreed that the exhibitor is ultimately responsible for payment of charges. If your named third party has not paid the invoice before the last day of the show, any outstanding balance will be charged to the exhibitor's credit card.

Exhibiting Company

Name of Exhibiting Company Phone # Fax #

Address City Prov/State Code/Zip

Authorized Name (print) Authorized Signature

CREDIT CARD AUTHORIZATION

MASTERCARD VISA AMERICAN EXPRESS EXPIRY DATE: _____

CORPORATE PERSONAL

CARD # _____

Cardholder's Name (print) Cardholder's Signature

Third Party / Exhibit House

Name of Third Party/Exhibit House Phone # Fax #

Address City Prov/State Code/Zip

Authorized Name (print) Authorized Signature

CREDIT CARD AUTHORIZATION

MASTERCARD VISA AMERICAN EXPRESS EXPIRY DATE: _____

CORPORATE PERSONAL

CARD # _____

Cardholder's Name (print) Cardholder's Signature

ALL GES SERVICES ARE TO BE CHARGED TO THE THIRD PARTY EXCEPT FOR THE FOLLOWING:

DISCOUNT PRICING:

To qualify for **Discount Pricing**, orders must be received **with payment in full on or before the deadline date.** Late orders will be charged the **Regular Prices.** Orders without payment cannot be processed until payment is received and could be charged the **Regular Price.**

METHOD OF PAYMENT:

GES accepts American Express, MasterCard, Visa, Debit Card, Cheque and Bank Wire Transfers. Purchase Orders are not considered payment. **Exhibitors will be charged a \$25.00 fee for returned NSF cheques.**

BANK WIRE TRANSFER INFORMATION:

To properly credit your account, please complete the **BANK WIRE TRANSFER FORM** included with the GES order forms and send the following information to the GES Exposition Services (Canada) Limited address listed on the Bank Wire Transfer Form.

NOTE: There is a minimum \$20.00 Service Charge (North America) \$40.00 (International) applicable on all wire transfers. Fees vary depending on banks processing wire transfers.

PAYMENT SCHEDULE:

Payment for all services must be pre-paid in full. GES will not provide Material Handling, In-Booth Forklifts, or Installation and Dismantle Labour Services without your company's **CREDIT CARD AUTHORIZATION FORM** on file.

THIRD PARTY BILLING:

You may arrange for an exhibit house or other agent to manage your exhibit & order services on your behalf. GES will agree to this arrangement if the exhibit house or agent makes satisfactory payment arrangements with us. In the event the authorized Third Party does not pay, each exhibiting company is ultimately responsible for all charges incurred on its behalf. See **THIRD PARTY BILLING REQUEST FORM.**

ADJUSTMENTS AND CANCELLATIONS:

Adjustments to your invoice **will not be made after the close of the show.** Some items, services and labour are subject to cancellation fees. Refer to each order form for details.

ALL EXHIBITORS MUST PAY 5% GST ON ALL ORDERS.



furnishings

Grey Fabric Side Chair



Grey Fabric Counter Stool



Grey Fabric Arm Chair



Steno Chair



30" Round / 30" High Pedestal Table



30" Round / 18" High Coffee Table



4', 6', OR 8' Long Raised Draped Table with White Vinyl Top



4', 6', OR 8' Long Draped Table with White Vinyl Top





furnishings

Coat Tree



22" W X 28" H
Chrome Sign Holder
(sign extra)



Easel



Gold Ballot Drum

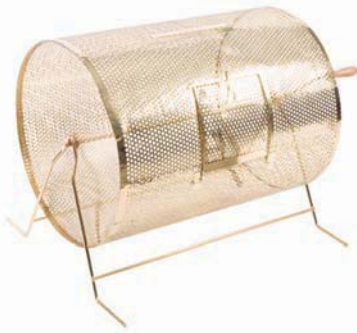

Plexi Pocket



40" W x 20" D x 36" H
White Counter Storage Unit



Bag Holder 41" H



Stanchions
6" Belt



Plastic
Wastebasket



FURNISHINGS ORDER FORM

#25, 5805 - 76 Ave. SE Calgary, Alberta, T2C 5L8 Tel: (403) 243-2212 Fax: (403) 243-3868 Toll Free 1-800-636-8235 www.gesexpo.ca

SHOW: **Calgary Renovation Show 2017**

EXHIBITOR INFORMATION

BOOTH #: _____

COMPANY _____

STREET _____

CITY _____ PROV/STATE _____ CODE _____

E-MAIL _____

PHONE _____ FAX _____

CONTACT NAME _____

DISCOUNT PRICE DEADLINE DATE: December 28, 2016

CREDIT CARD AUTHORIZATION

MASTERCARD VISA AMEX

--	--	--	--	--	--	--	--

EXPIRY DATE _____ / _____

CARDHOLDER NAME _____

CARDHOLDER SIGNATURE _____

CHEQUE ATTACHED (PAYABLE TO GES)

**ALL ORDERS MUST BE PREPAID IN FULL
(ORDERS CANNOT BE PROCESSED UNTIL PAYMENT IS RECEIVED)**

FURNISHINGS				
QTY	DESCRIPTION	DISCOUNT PRICE	REGULAR PRICE	TOTAL
	Grey Fabric Side Chair	\$41.00	\$57.00	
	Grey Fabric Counter Stool	\$89.50	\$125.50	
	Grey Fabric Arm Chair	\$42.00	\$74.50	
	Steno Chair	\$58.00	\$81.00	
	Cocktail Table 40" High	\$90.00	\$125.50	
	30" Round 30" High Pedestal Table	\$74.50	\$104.50	
	30" Round 18" High Coffee Table	\$57.00	\$79.50	
	Coat Tree	\$32.00	\$45.00	
	22" x 28" Chrome Sign Holder (Sign Extra)	\$48.50	\$68.00	
	Easel	\$41.00	\$57.50	
	Ballot Drum	\$65.00	\$91.00	
	Garment Rack on Wheels	\$46.50	\$65.00	
	White Counter Storage Unit 40" H	\$139.50	\$195.50	
	Bag Holder 41"H	\$68.00	\$95.50	
	Tape Stanchion	\$43.50	\$60.50	
	Wastebasket	\$22.50	\$32.00	

DRAPED DISPLAY TABLES 30" HIGH				
<input type="checkbox"/> BLACK <input type="checkbox"/> BLUE <input type="checkbox"/> BURGUNDY <input type="checkbox"/> GREEN <input type="checkbox"/> RED <input type="checkbox"/> SILVER <input type="checkbox"/> WHITE				
QTY	DESCRIPTION	DISCOUNT PRICE	REGULAR PRICE	TOTAL
	4 Ft. Long x 2 Ft. Wide	\$85.50	\$119.50	
	6 Ft. Long x 2 Ft. Wide	\$94.00	\$131.50	
	8 Ft. Long x 2 Ft. Wide	\$101.50	\$142.50	
	Drape Fourth Side	Add \$37.00 ea.		

RAISED DRAPED DISPLAY TABLES 42" HIGH				
<input type="checkbox"/> BLACK <input type="checkbox"/> BLUE <input type="checkbox"/> SILVER <input type="checkbox"/> WHITE				
QTY	DESCRIPTION	DISCOUNT PRICE	REGULAR PRICE	TOTAL
	4 Ft. Long x 2 Ft. Wide	\$97.50	\$136.50	
	6 Ft. Long x 2 Ft. Wide	\$120.00	\$168.00	
	8 Ft. Long x 2 Ft. Wide	\$147.00	\$206.00	
	Drape Fourth Side	Add \$37.00 ea.		

CUSTOM BOOTH DRAPING				
<input type="checkbox"/> BLACK <input type="checkbox"/> BLUE <input type="checkbox"/> RED <input type="checkbox"/> SILVER <input type="checkbox"/> WHITE				
	DESCRIPTION	DISCOUNT PRICE	REGULAR PRICE	TOTAL
	3 Ft. High (Per Linear Ft.)	\$7.00	\$10.00	
	8 Ft. High (Per Linear Ft.)	\$8.00	\$11.00	

Terms & Conditions

- All orders received after the Discount Price Date will be processed at the Regular Price.
- Exhibitor is responsible for all items for the duration of the show.
- If a colour is not chosen, GES will choose a colour for you.
- Charges are for rental of equipment only. All items remain the property of GES.
- GES is not responsible for exhibit materials left in GEM rental exhibits or counter storage units.
- All claims or discrepancies must be settled at the GES Service Centre prior to show closing.
- No refunds/exchanges on cancelled draped tables or custom booth draping once delivered. 50% refund on furnishings cancelled prior to show opening.

SUBTOTAL	
5% GST	
TOTAL	
GES #R104060264	

I have read and understand the Terms & Conditions of my Agreement with GES.

Signature

Date

CARPET ORDER FORM

#25, 5805 - 76 Ave. SE Calgary, Alberta, T2C 5L8 Tel: (403) 243-2212 Fax: (403) 243-3868 Toll Free 1-800-636-8235 www.gesexpo.ca

SHOW: Calgary Renovation Show 2017	DISCOUNT PRICE DEADLINE DATE: December 28, 2016								
EXHIBITOR INFORMATION	CREDIT CARD AUTHORIZATION								
BOOTH #: _____ COMPANY _____ STREET _____ CITY _____ PROV/STATE _____ CODE _____ E-MAIL _____ PHONE _____ FAX _____ CONTACT NAME _____	<input type="checkbox"/> MASTERCARD <input type="checkbox"/> VISA <input type="checkbox"/> AMEX <table border="1" style="width: 100%; height: 20px; border-collapse: collapse;"> <tr> <td style="width: 25px;"></td> <td style="width: 25px;"></td> <td style="width: 25px;"></td> <td style="width: 25px;"></td> <td style="width: 25px;"></td> <td style="width: 25px;"></td> <td style="width: 25px;"></td> <td style="width: 25px;"></td> </tr> </table> EXPIRY DATE ____ / ____ / ____ CARDHOLDER NAME _____ CARDHOLDER SIGNATURE _____ <input type="checkbox"/> CHEQUE ATTACHED (PAYABLE TO GES)								

**ALL ORDERS MUST BE PREPAID IN FULL
(ORDERS CAN NOT BE PROCESSED UNTIL PAYMENT IS RECEIVED)**

BOOTH CARPET - STANDARD SIZE
Note: Exhibitors ordering multiple pieces of carpet in this section may not receive the same dyelot.

QTY.	DESCRIPTION	DISCOUNT PRICE	REGULAR PRICE	TOTAL
	10 Ft. X 10 Ft. Single Booth	\$161.00	\$225.00	
	10 Ft. X 20 Ft. Double Booth	\$322.50	\$451.00	
COLOUR SELECTION: <input type="checkbox"/> BLACK <input type="checkbox"/> BLUE <input type="checkbox"/> GREY <input type="checkbox"/> RED				

BOOTH CARPET - CUSTOM SIZE
If your booth requires a size not listed above, please complete this section.

BOOTH SIZE: ____ Ft. x ____ Ft. = ____ Sq. Ft.	\$1.61/Sq. Ft.	\$2.26/Sq. Ft.	
COLOUR SELECTION: <input type="checkbox"/> BLACK <input type="checkbox"/> BLUE <input type="checkbox"/> GREY <input type="checkbox"/> RED			

UNDERPADDING PRICE PER SQUARE FOOT INSTALLED (100 SQ. FT. MIN.)

BOOTH SIZE: ____ Ft. x ____ Ft. = ____ Sq. Ft.	\$1.08/Sq. Ft.	\$1.51/Sq. Ft.	
---	----------------	----------------	--

PROTECTIVE PLASTIC COVERING PRICE PER SQUARE FOOT INSTALLED (STANDARD SIZES ONLY)

BOOTH SIZE: ____ Ft. x ____ Ft. = ____ Sq. Ft.	\$0.24/Sq. Ft.	\$0.33/Sq. Ft.	
---	----------------	----------------	--

PLEASE SELECT ONE FOR CUSTOM CARPET SIZES ONLY

IF ORDERING ELECTRICAL OR TELECOMMUNICATIONS SERVICES, WILL UNDER CARPET WIRING BE REQUIRED?

YES NO

Terms & Conditions

- All orders received after the Discount Price Date will be processed at the Regular Price.
- Exhibitor is responsible for all items for the duration of the show.
- No refunds/exchanges on carpets once delivered.
- Charges are for rental of equipment only. All items remain the property of GES.
- All claims or discrepancies must be settled at the GES Service Centre prior to show closing.
- If a colour is not chosen, GES will choose a colour for you. *Carpet colour subject to availability.*

SUBTOTAL	
5% GST	
TOTAL	
GST #R104060264	

I have read and understand the Terms & Conditions of my Agreement with GES.

Signature



Date

#25, 5805 - 76 Ave. SE Calgary, Alberta, T2C 5L8 Tel: (403) 243-2212 Fax: (403) 243-3868 Toll Free 1-800-636-8235 www.gesexpo.ca

SHOW: Calgary Renovation Show 2017	DISCOUNT PRICE DEADLINE DATE: December 28, 2016												
EXHIBITOR INFORMATION	CREDIT CARD AUTHORIZATION												
BOOTH #: _____	<input type="checkbox"/> MASTERCARD <input type="checkbox"/> VISA <input type="checkbox"/> AMEX <table border="1" style="width: 100%; height: 20px; border-collapse: collapse;"> <tr> <td style="width: 25px;"> </td><td style="width: 25px;"> </td><td style="width: 25px;"> </td><td style="width: 25px;"> </td> <td style="width: 25px;"> </td><td style="width: 25px;"> </td><td style="width: 25px;"> </td><td style="width: 25px;"> </td> <td style="width: 25px;"> </td><td style="width: 25px;"> </td><td style="width: 25px;"> </td><td style="width: 25px;"> </td> </tr> </table>												
COMPANY _____	EXPIRY DATE _____ / _____												
STREET _____	CARDHOLDER NAME _____												
CITY _____ PROV/STATE _____ CODE _____	CARDHOLDER SIGNATURE _____												
E-MAIL _____	<input type="checkbox"/> CHEQUE ATTACHED (PAYABLE TO GES)												
PHONE _____ FAX _____													
CONTACT NAME _____													

ALL ORDERS MUST BE PREPAID IN FULL (ORDERS CAN NOT BE PROCESSED UNTIL PAYMENT IS RECEIVED)

INITIAL CLEANING SERVICES	DAILY CLEANING SERVICES	ADDITIONAL CLEANING SERVICES
Performed evening prior to show opening • Carpets vacuumed	Performed prior to show opening and every night at show close for duration of show • Carpets vacuumed • Wastebaskets emptied	Performed upon request • For carpet in need of special attention due to food sampling demonstrations, hair, wood, metal shavings, grease or paint.

INITIAL CLEANING SERVICES RATES		DAILY CLEANING SERVICES RATES			ADDITIONAL CLEANING SERVICES RATES	
DISCOUNT PRICE	REGULAR PRICE	BOOTH SQUARE FOOT	DISCOUNT PRICE	REGULAR PRICE	DISCOUNT PRICE	REGULAR PRICE
\$0.40 / sq.ft.	\$0.56 / sq.ft.	50 - 600 sq.ft.	\$0.57/sq.ft.	\$0.80/sq.ft.	To Be Quoted	N/A
		601-1000 sq.ft.	\$0.48/sq.ft.	\$0.67/sq.ft.		
		OVER 1000sq.ft.	\$0.40/sq.ft.	\$0.56/sq.ft.		

SELECT SERVICE REQUIRED:

Initial Cleaning _____ @ _____ = _____
 Daily Cleaning Total sq.ft.of Booth \$ Per sq.ft. Total
 Additional Services

Terms & Conditions

- All orders received after the Discount Price Date will be processed at the Regular Price.
- No cancellations after move-in begins.
- All claims or discrepancies must be settled at the GES Service Centre prior to show closing.
- All orders are governed by GES Limits of Liability and Responsibility

SUBTOTAL	
5% GST	
TOTAL	
GST #R104060264	

I have read and understand the Terms & Conditions of my Agreement with GES.

Signature

Date

#25, 5805 - 76 Ave. SE Calgary, Alberta, T2C 5L8 Tel: (403) 243-2212 Fax: (403) 243-3868 Toll Free 1-800-636-8235 www.gesexpo.ca

SHOW: Calgary Renovation Show 2017	DISCOUNT PRICE DEADLINE DATE: December 28, 2016				
EXHIBITOR INFORMATION	CREDIT CARD AUTHORIZATION				
BOOTH #: _____	<input type="checkbox"/> MASTERCARD <input type="checkbox"/> VISA <input type="checkbox"/> AMEX				
COMPANY _____	<table border="1" style="width:100%; height: 20px; border-collapse: collapse;"> <tr> <td style="width: 25%;"> </td> <td style="width: 25%;"> </td> <td style="width: 25%;"> </td> <td style="width: 25%;"> </td> </tr> </table>				
STREET _____	EXPIRY DATE _____ / _____				
CITY _____ PROV/STATE _____ CODE _____	CARDHOLDER NAME _____				
E-MAIL _____	CARDHOLDER SIGNATURE _____				
PHONE _____ FAX _____	<input type="checkbox"/> CHEQUE ATTACHED (PAYABLE TO GES)				
CONTACT NAME _____					

Show Special

→ Spend less
→ Sell More
→ Look great

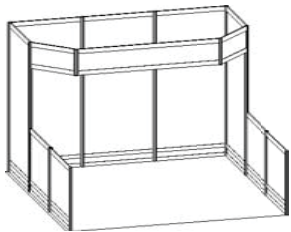

\$1000.50

PACKAGE A: 10'x10' BOOTH

- Header Sign - 12"x78"
- Infill Panels
- Colour Coordinated 10'x10' Carpet
- Price after Deadline Date: **\$1,400.50**

- ✓ Installed and Dismantled
- ✓ Ready before you arrive
- ✓ No Labour Costs
- ✓ No Trucking Costs
- ✓ No Material Handling Costs
- ✓ Includes Carpet
- ✓ Includes Header Sign(s)
- ✓ Choice of Colours
- ✓ Accessories Available

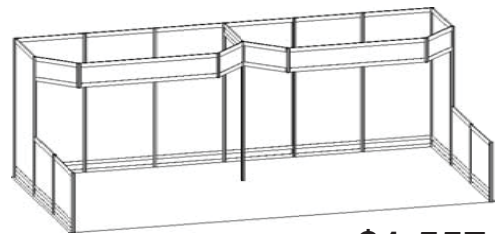

\$1,557.50

PACKAGE B: 10'x20' BOOTH

- 2 Header Signs - 12"x78" each
- Infill Panels
- Colour Coordinated 10'x20' Carpet
- Price after Deadline Date: **\$2,180.50**

Indicate Date and Time you plan to arrive to merchandise your exhibit: _____
Date Time

PLEASE COMPLETE THE FOLLOWING:	
SIZE ORDERED:	PACKAGE A: <input type="checkbox"/> 10'x10' PACKAGE B: <input type="checkbox"/> 10'x20'
Infill Panel Colour: White Only	
Carpet Colour: <input type="checkbox"/> Black <input type="checkbox"/> Blue <input type="checkbox"/> Red <input type="checkbox"/> Grey	
<i>(All panel & carpet colours subject to availability.)</i>	
Package A Identification Sign to Read: _____	
Package B Identification Sign to Read: Left: _____ Right: _____	
<input type="checkbox"/> Custom Header to be added	
Please e-mail artwork to: calgarygraphics@ges.com Label e-mail with Exhibitor Name & Show Name/Date (file must be eps, ai, cdr)	
Custom Header Signs/Logos will be charged \$100.00 extra per sign	
ALL ORDERS MUST BE PREPAID IN FULL	
(ORDERS CAN NOT BE PROCESSED UNTIL PAYMENT IS RECEIVED)	

Terms & Conditions

- Does not include lighting or electrical service.
- No refunds/exchanges once show move-in begins.
- All claims or discrepancies must be settled prior to show closing.
- All orders received after the Discount Price Date will be processed at the Regular Price.
- GES is not responsible for exhibit materials left in GEM rental exhibits or counter storage units.

I have read and understand the Terms & Conditions of my Agreement with GES.

SUBTOTAL	
5% GST	
TOTAL	
	GST #R104060264

Signature

Date

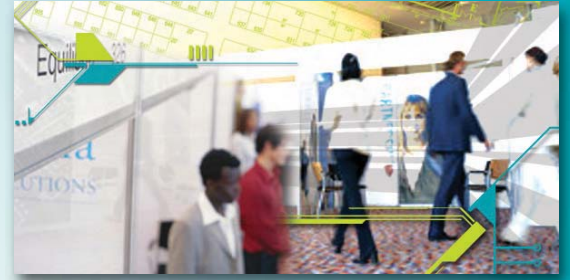

standard exhibit rentals

10' X 10'
EXHIBITS

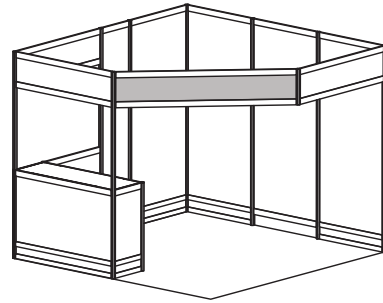

● GEM Model #1 - 10'x10' Corner

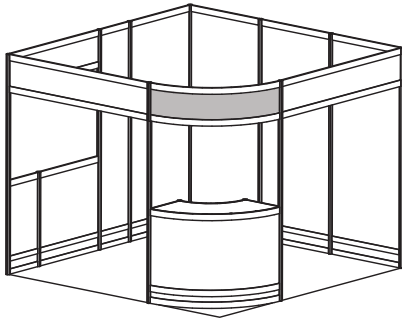

● GEM Model #2 - 10'x10' Corner

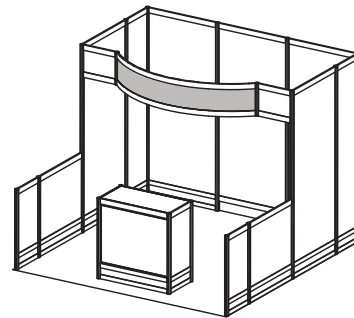

● GEM Model #3 - 10'x10'

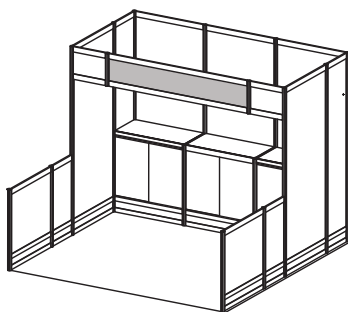

● GEM Model #4 - 10'x10'

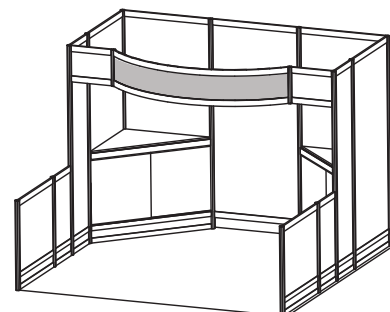

● GEM Model #5 - 10'x10'

3 Easy Steps →

- 1 Select the model number that suits your needs
- 2 Choose carpet and panel colours on the GEM Exhibit Rental order form
- 3 Complete & send order form

Grey indicates standard header sign(s)

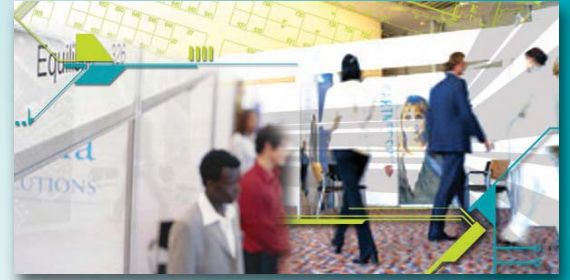

standard exhibit rentals

10' X 20'
EXHIBITS

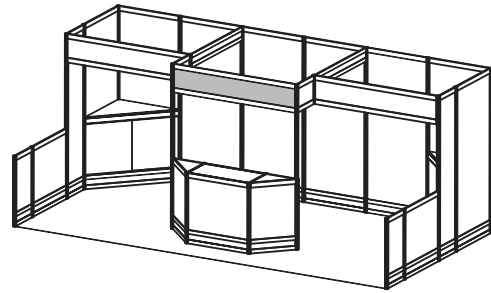

● GEM Model #6 - 10'x20'

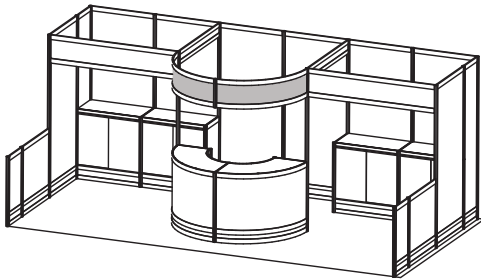

● GEM Model #7 - 10'x20'

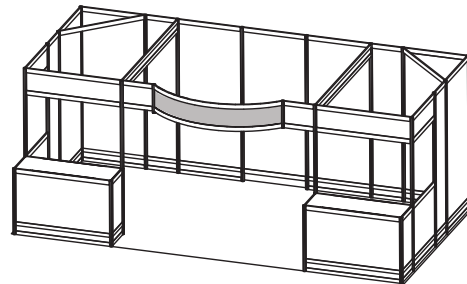

● GEM Model #8 - 10'x20'

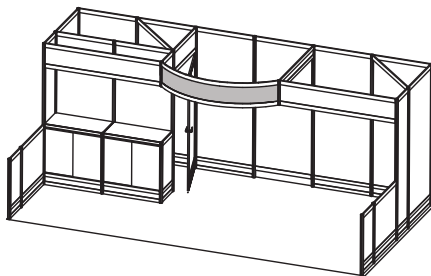

● GEM Model #9 - 10'x20'

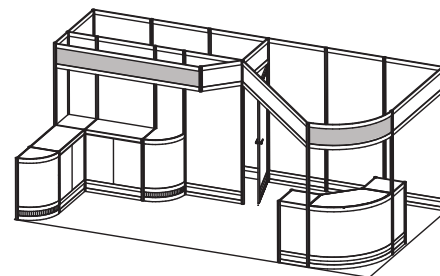

● GEM Model #10 - 10'x20' Corner

3 Easy Steps

- 1 Select the model number that suits your needs
- 2 Choose carpet and panel colours on the GEM Exhibit Rental order form
- 3 Complete & send order form

Grey indicates standard header sign(s)

GEM EXHIBIT SYSTEM ORDER FORM

#25, 5805 - 76 Ave. SE Calgary, Alberta, T2C 5L8 Tel: (403) 243-2212 Fax: (403) 243-3868 Toll Free 1-800-636-8235 www.gesexpo.ca

SHOW: **Calgary Renovation Show 2017**

EXHIBITOR INFORMATION

BOOTH #: _____

COMPANY _____

STREET _____

CITY _____ PROV/STATE _____ CODE _____

E-MAIL _____

PHONE _____ FAX _____

CONTACT NAME _____

DISCOUNT PRICE DEADLINE DATE: **December 28, 2016**

CREDIT CARD AUTHORIZATION

MASTERCARD
 VISA
 AMEX

--	--	--	--	--	--	--	--

EXPIRY DATE _____ / _____

CARDHOLDER NAME _____

CARDHOLDER SIGNATURE _____

CHEQUE ATTACHED (PAYABLE TO GES)

ALL ORDERS MUST BE PREPAID IN FULL (ORDERS CANNOT BE PROCESSED UNTIL PAYMENT IS RECEIVED)

Model Number	Discount Price	Regular Price	Model Number	Discount Price	Regular Price
Model #1	\$1,181.00	\$1,653.50	Model #6	\$2,344.50	\$3,282.50
Model #2	\$1,269.50	\$1,777.50	Model #7	\$3,002.00	\$4,203.00
Model #3	\$1,359.50	\$1,903.00	Model #8	\$2,512.50	\$3,517.50
Model #4	\$1,616.00	\$2,262.00	Model #9	\$2,779.50	\$3,891.00
Model #5	\$1,727.00	\$2,418.00	Model #10	\$3,370.00	\$4,718.00

Package Includes: Installation & Dismantling, Choice of Carpet Colour, Choice of Panel Colour, Company Identification Sign

Package Does Not Include: Cleaning, Light Fixtures or Electrical Outlets

PLEASE COMPLETE THE FOLLOWING: MODEL NUMBER: *Upgrade options available. Contact Exhibitor Services.*

Font Colour: Black

Infill Panel Colour: Black Blue Grey White

Carpet Colour: Black Blue Grey Red *(All panel & carpet colours subject to availability.)*

Models 1, 2, 3, 4, 5, 6, 8 or 9 Identification Sign to Read: _____

Models 7 or 10 Identification Sign to Read: Left: _____ Right: _____

Indicate Date & Time for Arrival: _____

Custom Header Signs/Logos will be charged \$100.00 extra per sign

ALL ORDERS MUST BE PREPAID IN FULL (ORDERS CANNOT BE PROCESSED UNTIL PAYMENT IS RECEIVED)

Terms & Conditions

- Payment may be made by cheque up to two weeks prior to the 1st day of move in.
- All orders received after the Discount Price Date will be processed at the Regular Price.
- Exhibitor is responsible for all items for the duration of the show.
- Charges are for rental of equipment only. All items remain the property of GES.
- No refunds/exchanges once show move-in begins. All claims or discrepancies must be settled prior to show closing.
- GES is not responsible for exhibit materials left in GEM rental exhibits or counter storage units.

SUBTOTAL	
5% GST	
TOTAL	
	GST #R104060264

I have read and understand the Terms & Conditions of my Agreement with GES.

Signature Date

#25, 5805 - 76 Ave. SE Calgary, Alberta, T2C 5L8 Tel: (403) 243-2212 Fax: (403) 243-3868 Toll Free 1-800-636-8235 www.gesexpo.ca

SHOW: **Calgary Renovation Show 2017**

EXHIBITOR INFORMATION

BOOTH #: _____

COMPANY _____

STREET _____

CITY _____ PROV/STATE _____ CODE _____

E-MAIL _____

PHONE _____ FAX _____

CONTACT NAME _____

DISCOUNT PRICE DEADLINE DATE: December 28, 2016

CREDIT CARD AUTHORIZATION

MASTERCARD VISA AMEX

_____|_____|_____|_____|_____|_____|_____|_____|_____|_____|

EXPIRY DATE ____/____/____

CARDHOLDER NAME _____

CARDHOLDER SIGNATURE _____

CHEQUE ATTACHED (PAYABLE TO GES)

ALL ORDERS MUST BE PREPAID IN FULL
(ORDERS CAN NOT BE PROCESSED UNTIL PAYMENT IS RECEIVED) LIGHTS ARE INCLUDED IN SHOWCASES (ELECTRICAL SERVICES EXTRA)

QTY	#	DESCRIPTION	DISCOUNT PRICE	REGULAR PRICE	TOTAL
	1	Pedestal (White) 20"L x 20"W □ 28"H or □ 36"H	\$91.50	\$128.00	
	2	Pedestal White 40"L X 40"W (Tops are 20" X 20") (Unit Heights - 16"- 28" & 28"- 40")	\$458.50	\$642.00	
	3	Storage Counter (White) 80"L X 20"W X 40"H	\$272.50	\$381.50	
	4	Curved Counter (White) 60"L X 20"W X 40"H	\$187.00	\$262.00	
	5	99A Showcase (White/Glass) 40"L X 20"W X 40"H	\$187.00	\$262.00	
	6	99B Showcase (White/Glass) 40"L X 20"W X 40"H	\$190.50	\$266.50	
	7	99C Showcase (White/Glass) 26"L X 26"W X 96"H	\$276.00	\$386.00	
	8	99D Showcase (White/Glass) 40"L X 20"W X 96"H	\$390.00	\$546.00	

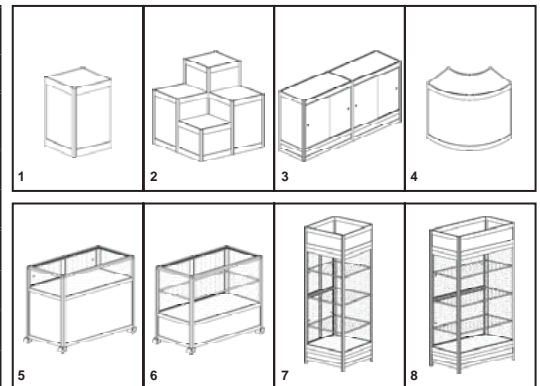

QTY	#	DESCRIPTION	DISCOUNT PRICE	REGULAR PRICE	TOTAL
	A	Waterfall With Eight Balls	\$18.50	\$25.50	
	C	Garmet Rail 39"W	\$47.50	\$66.50	
	D	Shelves □ Flat □ Angled 37"L X 12"W	\$40.00	\$56.00	
	E	Slatwall Panels - 37"W X 96"H Grey (Upgrade for standard panels)	\$110.50	\$154.50	

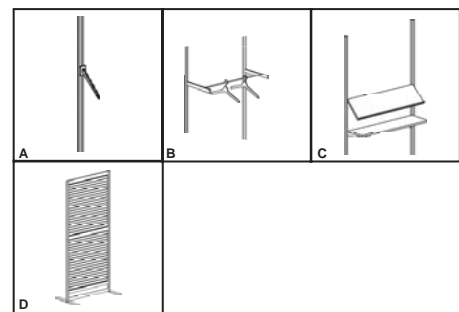

To Be Able To Rent These Accessories, You Must Order a GEM Hardwall Booth From GES

Please Attach Diagram Of Booth Indicating Locations For Grid Panels And/Or Slatwall. Grid Panels Cannot Be Installed In Corners.

Terms & Conditions

- All items subject to availability.
- No refunds/exchanges once show move-in begins.
- All claims or discrepancies must be settled prior to show closing.
- Exhibitor is responsible for all items for the duration of the show.
- Charges are for rental of equipment. All items remain the property of GES.
- All orders received after the Discount Price Date will be processed at the Regular Price.

SUBTOTAL	_____
5% GST	_____
TOTAL	_____
	GST #R104060264

I have read and understand the Terms & Conditions of my Agreement with GES.

Signature

Date

SIGN ORDER FORM

#25, 5805 - 76 Ave. SE Calgary, Alberta, T2C 5L8 Tel: (403) 243-2212 Fax: (403) 243-3868 Toll Free 1-800-636-8235 www.gesexpo.ca

SHOW: **Calgary Renovation Show 2017**

EXHIBITOR INFORMATION

BOOTH #: _____

COMPANY _____

STREET _____

CITY _____ PROV/STATE _____ CODE _____

E-MAIL _____

PHONE _____ FAX _____

CONTACT NAME _____

DISCOUNT PRICE DEADLINE DATE: December 28, 2016

CREDIT CARD AUTHORIZATION

MASTERCARD VISA AMEX

--	--	--	--	--	--	--	--	--	--	--	--	--	--	--	--

EXPIRY DATE ____ / ____

CARDHOLDER NAME _____

CARDHOLDER SIGNATURE _____

CHEQUE ATTACHED (PAYABLE TO GES)

**ALL ORDERS MUST BE PREPAID IN FULL
(ORDERS CAN NOT BE PROCESSED UNTIL PAYMENT IS RECEIVED)**

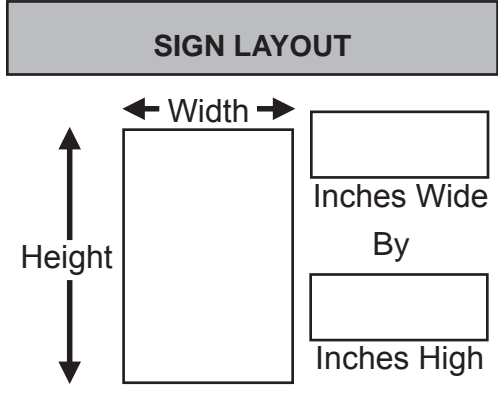

Sign Sizes	Discount Price	Regular Price
11" x 14"	\$ 45.50	\$ 63.50
14" x 22"	\$ 64.00	\$ 89.50
22" x 28"	\$ 99.50	\$139.50
7" x 44"	\$ 64.00	\$ 89.50
28" x 44"	\$170.50	\$238.50
40" x 60"	\$259.50	\$363.50

LOGOS ARE NOT INCLUDED IN PRICING

PLEASE PRINT OR TYPE WORDING REQUIRED:

ALL SIGNS MUST BE PICKED UP FROM OUR ON-SITE SERVICE DESK.

Terms & Conditions

- All orders received after the Discount Price Date will be processed at the Regular Price.
- There are no refunds/exchanges on signs.
- All claims or discrepancies must be settled at the GES Service Centre prior to show closing.

SUBTOTAL	_____
5% GST	_____
TOTAL	_____
GST #R104060264	

I have read and understand the Terms & Conditions of my Agreement with GES.

Signature

Date

LABOUR SERVICE ORDER FORM

#25, 5805 - 76 Ave. SE Calgary, Alberta, T2C 5L8 Tel: (403) 243-2212 Fax: (403) 243-3868 Toll Free 1-800-636-8235 www.gesexpo.ca

SHOW: **Calgary Renovation Show 2017**

EXHIBITOR INFORMATION

BOOTH #: _____

COMPANY _____

STREET _____

CITY _____ PROV/STATE _____ CODE _____

E-MAIL _____

PHONE _____ FAX _____

CONTACT NAME _____

DISCOUNT PRICE DEADLINE DATE: December 28, 2016

CREDIT CARD AUTHORIZATION

MASTERCARD VISA AMEX

_____|_____|_____|_____|_____|_____|_____|_____|_____|_____|

EXPIRY DATE ____/____/____

CARDHOLDER NAME _____

CARDHOLDER SIGNATURE _____

CHEQUE ATTACHED (PAYABLE TO GES)

CREDIT CARD AUTHORIZATION (ABOVE) MUST BE COMPLETED AS METHOD OF PAYMENT FOR THIS SERVICE

LABOUR RATES ARE CHARGED PER PERSON AT **A MINIMUM CHARGE OF ONE HOUR**. LABOUR OVER ONE HOUR IS CHARGED IN 1/2 HOUR INCREMENTS. (A 30% SURCHARGE WILL BE APPLIED TO ON-SITE ORDERS)

Straight Time 8:00am - 4:00pm Monday - Friday \$ 72.50 PER HOUR	Overtime After 4:00pm Weekdays & All Day Sat, Sun and holidays \$108.50 PER HOUR
--	---

EXHIBITOR MUST REPORT TO GES SERVICE CENTRE TO RECEIVE THEIR LABOUR

INSTALLATION Set Up Drawings or Photos Attached: yes no

Carrier: _____ Delivery Date: _____ Day / Date/ Month / Year Delivery Time: _____ am pm

SUPERVISION By Exhibitor (Provide Name of Rep): _____ (Exhibitor MUST be Present to Supervise) By GES ^{30% surcharge applies} (Exhibitor does NOT have to be present)

DATE LABOUR REQUIRED: _____ Day / Date/ Month / Year START TIME REQUIRED: _____ am pm

NUMBER OF PEOPLE REQUIRED X HOURS PER PERSON = TOTAL HOURS

DISMANTLING

Carrier: _____ Pick-up Date: _____ Day / Date/ Month / Year Pick-up Time: _____ am pm

SUPERVISION By Exhibitor (Provide Name of Rep): _____ (Exhibitor MUST be Present to Supervise) By GES ^{30% surcharge applies} (Exhibitor does NOT have to be present)

DATE LABOUR REQUIRED: _____ Day / Date/ Month / Year START TIME REQUIRED: _____ am pm

NUMBER OF PEOPLE REQUIRED X HOURS PER PERSON = TOTAL HOURS

- Terms & Conditions**
- When Exhibitor is supervising labour the Exhibitor must check labour in and out at the GES Service Centre.
 - We reserve the right to change labourers and/or rates as shifts change.
 - All claims or discrepancies must be settled within one week of show closing.
 - Uncancelled labour will be charged a minimum fee of 1 hour per person.
 - GES Limits of Liability apply.

I have read and understand the Terms & Conditions of my Agreement with GES.

Signature

Date

GST #R104060264

IN BOOTH FORKLIFT ORDER FORM

#25, 5805 - 76 Ave. SE Calgary, Alberta, T2C 5L8 Tel: (403) 243-2212 Fax: (403) 243-3868 Toll Free 1-800-636-8235 www.gesexpo.ca

SHOW: Calgary Renovation Show 2017

EXHIBITOR INFORMATION

BOOTH #: _____

COMPANY _____

STREET _____

CITY _____ PROV/STATE _____ CODE _____

E-MAIL _____

PHONE _____ FAX _____

CONTACT NAME _____

DISCOUNT PRICE DEADLINE DATE: December 28, 2016

CREDIT CARD AUTHORIZATION

MASTERCARD VISA AMEX

_____|_____|_____|_____|_____|_____|_____|_____|_____|_____|

EXPIRY DATE _____ / _____

CARDHOLDER NAME

CARDHOLDER SIGNATURE

CHEQUE ATTACHED (PAYABLE TO GES)

CREDIT CARD AUTHORIZATION (ABOVE) MUST BE COMPLETED AS METHOD OF PAYMENT FOR THIS SERVICE

IN-BOOTH FORKLIFT SERVICE IS AVAILABLE TO EXHIBITORS REQUIRING ASSISTANCE WITH POSITIONING OF EXHIBITOR MATERIALS WITHIN YOUR BOOTH SPACE. (MINIMUM CHARGE OF 1 HOUR.)

THIS SERVICE IS NOT PAID FOR BY SHOW MANAGEMENT

Straight Time
8:00am - 4:00pm
Monday - Friday
\$110.50 PER HOUR

Overtime
4:00pm - 6:00pm
Monday - Friday
8:00am - 4:00pm Sat & Sun
\$165.50 PER HOUR

A 30% SURCHARGE WILL BE APPLIED TO ON-SITE ORDERS.
ALL RATES INCLUDE FORKLIFT AND DRIVER (5% GST IS APPLICABLE)

PLEASE COMPLETE THE FOLLOWING:

SUPERVISOR NAME: _____ (EXHIBITOR MUST BE PRESENT TO SUPERVISE)

INSTALLATION TIME REQUIRED: _____ Day _____ Date _____ Month _____ # of Hours _____ # of Forklifts _____

DISMANTLING TIME REQUIRED: _____ Day _____ Date _____ Month _____ # of Hours _____ # of Forklifts _____

APPROXIMATE TIMES:

MOVE-IN Start: _____ am pm Finish: _____ am pm Total Hours: _____

MOVE-OUT Start: _____ am pm Finish: _____ am pm Total Hours: _____

SERVICES OVER 1 HOUR MINIMUM WILL BE CHARGED IN 1/2 HOUR INCREMENTS PER FORKLIFT.

Terms & Conditions

- Exhibitor must check forklift/driver in and out at the GES Service Centre.
- We reserve the right to change labourers and/or rates as shifts change.
- All claims or discrepancies must be settled within one week of show closing.
- GES Limits of Liability apply.

I have read and understand the Terms & Conditions of my Agreement with GES.

Signature

Date

GST #R104060264

1. GES CANADA Exposition Services herein known as GES and its subcontractors shall not be responsible for damage to uncrated materials; materials improperly packed, glass breakage or concealed damage.

2. Relative to inbound shipments, there may be a lapse of time between the delivery of shipment(s) to the booth by GES or its subcontractors and the arrival of the Exhibitor's representative at the booth. Similarly, relative to outgoing shipment(s), it is possible that there will be a lapse of time between the completion of packing and the actual pick-up of materials from the booth for loading onto a carrier. It is understood that during such times the shipment(s) will be left in the booth unattended.

Therefore, it is agreed that GES and its subcontractors are not responsible for the loss or disappearance of Exhibitor's materials after the same have been delivered to Exhibitor's booth, nor are GES and its subcontractors responsible for Exhibitor's materials before they are picked up from the Exhibitor's booth for loading after the show. Consequently, all bills of lading covering outgoing shipment(s) submitted to GES or its subcontractors by Exhibitor will be checked at the time of pick-up from the booth and corrected where discrepancies exist.

3. GES and its subcontractors shall not be held liable for any damage incurred during the handling of equipment requiring special devices to properly load, place or reload unless advance notice has been given to GES in time to obtain the proper equipment.

4. GES and its subcontractors shall not be responsible for loss, delay or damage due to strikes, lockouts or work stoppages of any kind.

5. GES and its subcontractors shall not be responsible for ordinary wear and tear in handling of equipment, nor for loss or damage due to fire, theft, windstorm, water, vandalism, acts of God, mysterious disappearance or other causes beyond their control.

6. It is understood that GES and its subcontractors are not insurers. Insurance, if any, shall be obtained by the Exhibitor. Amounts payable to GES hereunder are based on the scope of the liability as herein set forth and are unrelated to the value of the Exhibitor's property. It is further understood and agreed that GES and its subcontractors do not provide for full liability should loss or damage occur. It is agreed that if GES or its subcontractors should be found liable for loss or damage to Exhibitor's equipment, the liability shall be limited to the specific article that was physically lost or damaged. Such liability shall be limited to a sum equal to \$0.30 per pound per article, with a maximum liability of \$50.00 per item or \$1,000.00 per shipment, whichever is less, as agreed upon damages and exclusive remedy. Provisions of this paragraph shall apply if loss or damage, regardless of cause or origin, results directly or indirectly to property through performance services to

Exhibitor's or from negligence, active or otherwise, by GES, its subcontractors or their employees.

7. GES and its subcontractors shall not be liable to any extent whatsoever for any actual, potential or assumed loss of profits or revenues or for any collateral costs that may result from any loss or damage to Exhibitor's materials which may make it impossible or impracticable to exhibit same.

8. Claims for loss or damage must be submitted to GES by the close of the show. No suit or action shall be brought against GES or its subcontractors more than one year after the cause of action.

9. The Exhibitor agrees, in connection with the receipt, handling, temporary storage and reloading of its materials, that GES and its subcontractors will provide these services as Exhibitor's agent and not as bailee or shipper. If any employee of GES or its subcontractors shall sign a delivery receipt, bill of lading or other document, we agree that GES or its subcontractor will do so as the Exhibitor's agent, and the Exhibitor accepts the responsibility thereof.

10. GES and its subcontractors shall not be liable for shipments received without receipts, freight bills or specified unit counts on receipts or freight bills, such as a courier or van lines. Such shipments will be delivered to booth without guarantee of piece count or condition.

11. Empty container labels will be available at the GES Service Centre. Affixing the labels is the sole responsibility of the Exhibitor or its representative. It is understood that these labels are used for EMPTY STORAGE ONLY, and GES and its subcontractors assume no responsibility for loss or damage to contents while containers are in storage or for mislabelled containers.

12. In order to expedite removal of materials from the show site, GES shall have the authority to change designated carriers, if such carriers do not pick up on time. Where no disposition is made by the Exhibitor, materials will be taken to a warehouse to await Exhibitor's shipping instructions, and the Exhibitor agrees to be responsible for payment of charges relating to such handling at the warehouse. GES assumes no liability as a result of such re-routing or handling.

13. The Exhibitor agrees, in the event of a dispute with GES or its subcontractors relative to any loss or damage to any of your materials or equipment, that the Exhibitor will not withhold payment in any amount due to GES for material handling services or any other services provided by GES or its subcontractors as an offset against the amount of the alleged loss or damage. Instead, the Exhibitor agrees to pay GES prior to the close of the show for all such charges and further agrees that any claim the Exhibitor may have against GES or its subcontractors shall be pursued independently by the Exhibitor as a completely separate transaction to be resolved on its own merits.

The consignment or delivery of a shipment to GES or its subcontractors by an Exhibitor or by any shipper on behalf of the Exhibitor shall be construed as an acceptance by such Exhibitor (and/or other shipper) of the terms and conditions set forth in Sections 1 through 13 above.

Be sure your materials are insured from the time they leave your firm until they are returned after the show. It is suggested that Exhibitors arrange all risk coverage. This can usually be done by riders to existing policies. Contact your insurance representative. Be sure your liability insurance is in effect during transit and return of your materials, during storage and at show site.